

Installation Manual

Balboa Bluetooth Audio bba™ 2





WARNING

There are no user serviceable parts inside the system pack. All connections must be made by a qualified electrician in accordance with the country or local electrical codes in effect at the time of installation.



System Pack

Parts List

Equipment included in the box

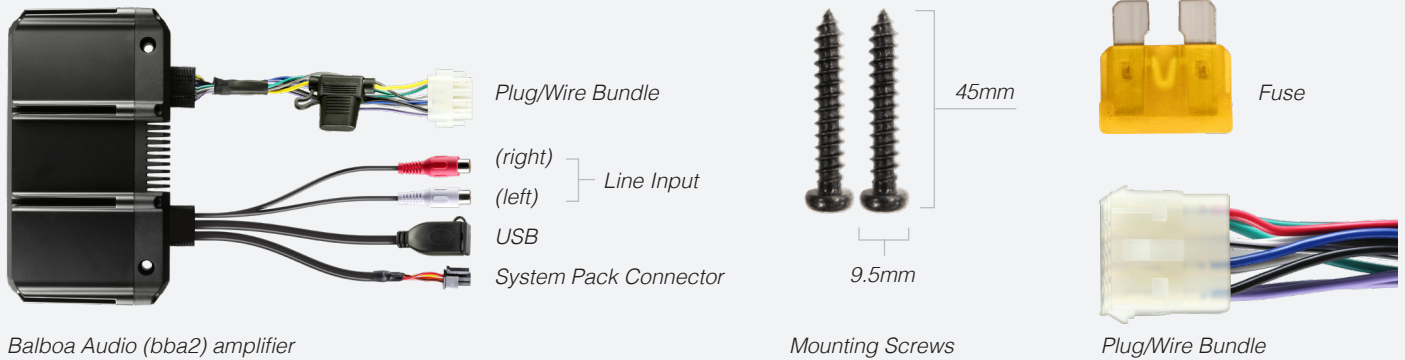

Spa Equipment

The system pack and all electronic components connected to the system pack are referred to as **"system"** in this manual.

The power supply connects to the system pack at the circuit board connector labeled "A / V." Refer to the system pack wire diagram for circuit board connector positions. The wire diagram is inside the system pack.

Topside Panel Options

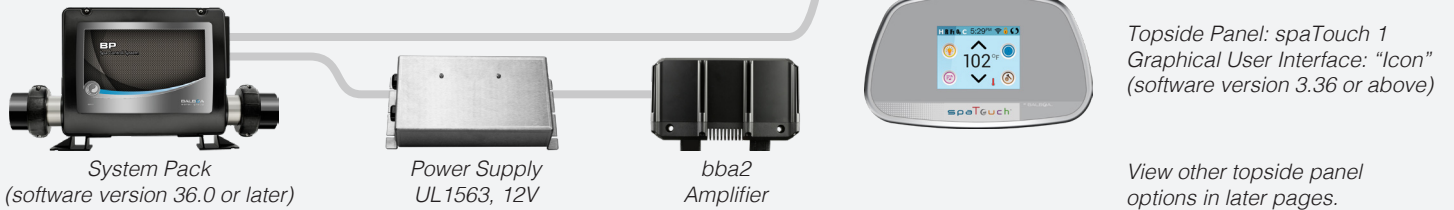

Audio Equipment

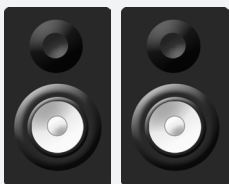

Speakers



Sub woofer
(See page 5 for limitations.)



Smart Device
(iOS, Android, etc)

bba2 works with iOS and Android phones and tablets.

bba[™]2 New/Redesigned Features

The following features are compatible with the spaTouch1 topside panel, GUI: "Icon," software version 3.36 or above, as well as the spaTouch 2.

Song and metadata display:

- Artist
- Song
- Song length and elapsed time

Audio EQ (equalizer) modes:

- Jazz, Rock, Hall, etc.

USB input

Enhanced bass

Redesigned Module

New Bluetooth Radio

- BT3.0-HS/BT4.0 EDR
- Range: up to 100 feet in open air.

Ranges vary as they are dependant on installations.

New plastic enclosure

- IPx5 waterproof

Tech Specs

Speaker impedance

- 2-8 ohms

Output power

- (2 ohm load) 4x55W (80W max)
- (4 ohm load) 4x30W (50W max)

Operating voltage

- 10.5V-15V DC

Max current draw at full power out

- 9-15 amps

Dimensions

- 8"wide X 3" high X 4.3" deep
- (20.32 cm X 7.62 cm X 10.92 cm)

Weight

- 2.0 lbs. (0.9 Kg)

4 channel Amp

- Sub woofer from the rear 2 channels

bba2™ Amp Connections

Plug/Wire Bundle Chart		
Wire Color	Wire #	Wire Function
Red	1	B + (+ 12VDC)
Green w/stripe	2	Rear Left Speaker -
Green	3	Rear Left Speaker +
no wire (blank)	4	no wire (blank)
White w/stripe	5	Front Left Speaker -
White	6	Front Left Speaker +
Blue	7	B + (+ 12VDC)
Gray w/stripe	8	Front Right Speaker -
Gray	9	Front Right Speaker +
Black	10	Ground (neg)
Violet w/stripe	11	Rear Right Speaker -
Violet	12	Rear Right Speaker +

Wire the plug/wire bundle to the 12VDC power source, left and right speakers, and sub woofer. The numbers in “Plug/Wire Bundle Chart” correspond with the numbers in “Plug/Wire Bundle Diagram 1” and “Plug/Wire Bundle Diagram 2.”

Plug/Wire Bundle
Female Side View (photo)

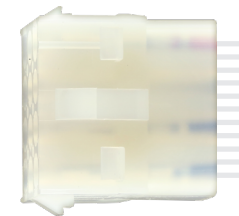
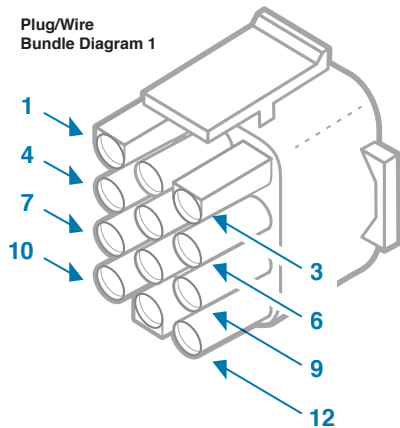
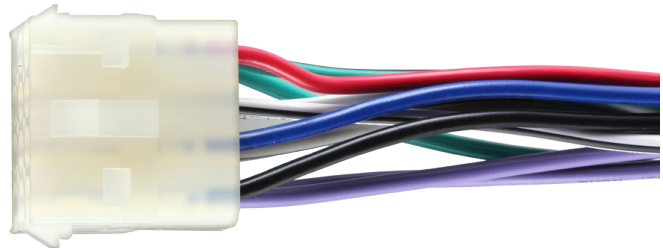

Plug/Wire Bundle Diagram 2
Female Side View (photo)

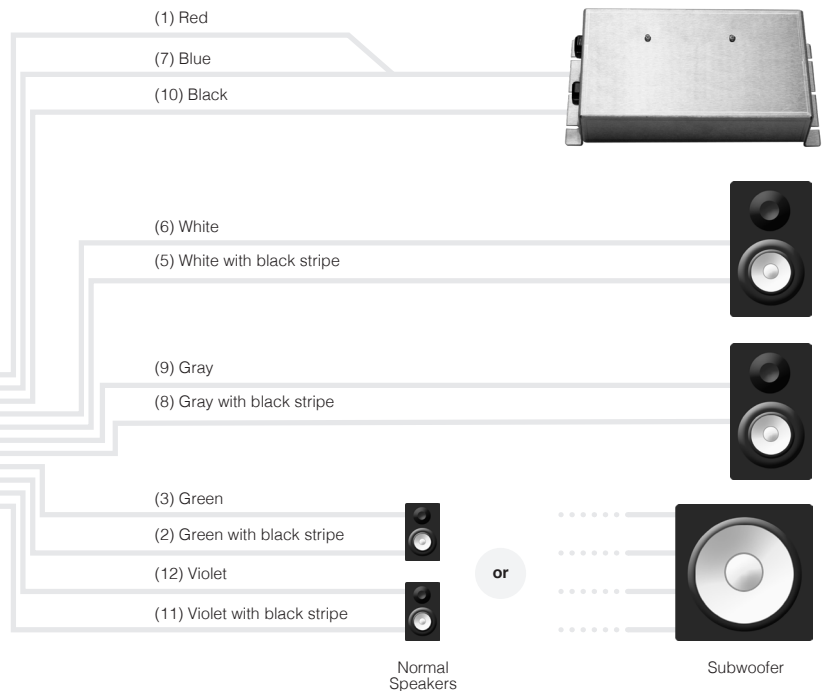

This manual only specifies audio connections to a subwoofer. If the subwoofer needs other connections, such as power, refer to the subwoofer documentation for those connections.

Note: only a system with a spaTouch 2 or spaTouch 1 (with an “Icon” graphic user interface) connected can be configured to use a subwoofer.

If a sub woofer is used, the low pass filter setting needs to be enabled on the audio settings screen (see page 12) .

bbaTM2 Mounting Instructions

1 - Choose a well ventilated mounting surface. The bba2 amplifier generates significant heat when operating at high power levels.

2 - To insure a good Bluetooth connection, the mounting surface should be elevated from the ground.

3 - It is preferable to mount bba2 such that the heat sink fins are vertical or facing upward.

4 - Drill pilot holes in the mounting surface that correspond with the 2 mounting holes in the bba2 amplifier. Be sure not to drill into any critical areas of the spa.

5 - Fasten the bba2 amplifier to the surface securely with the mounting screws.

Continue to next page.

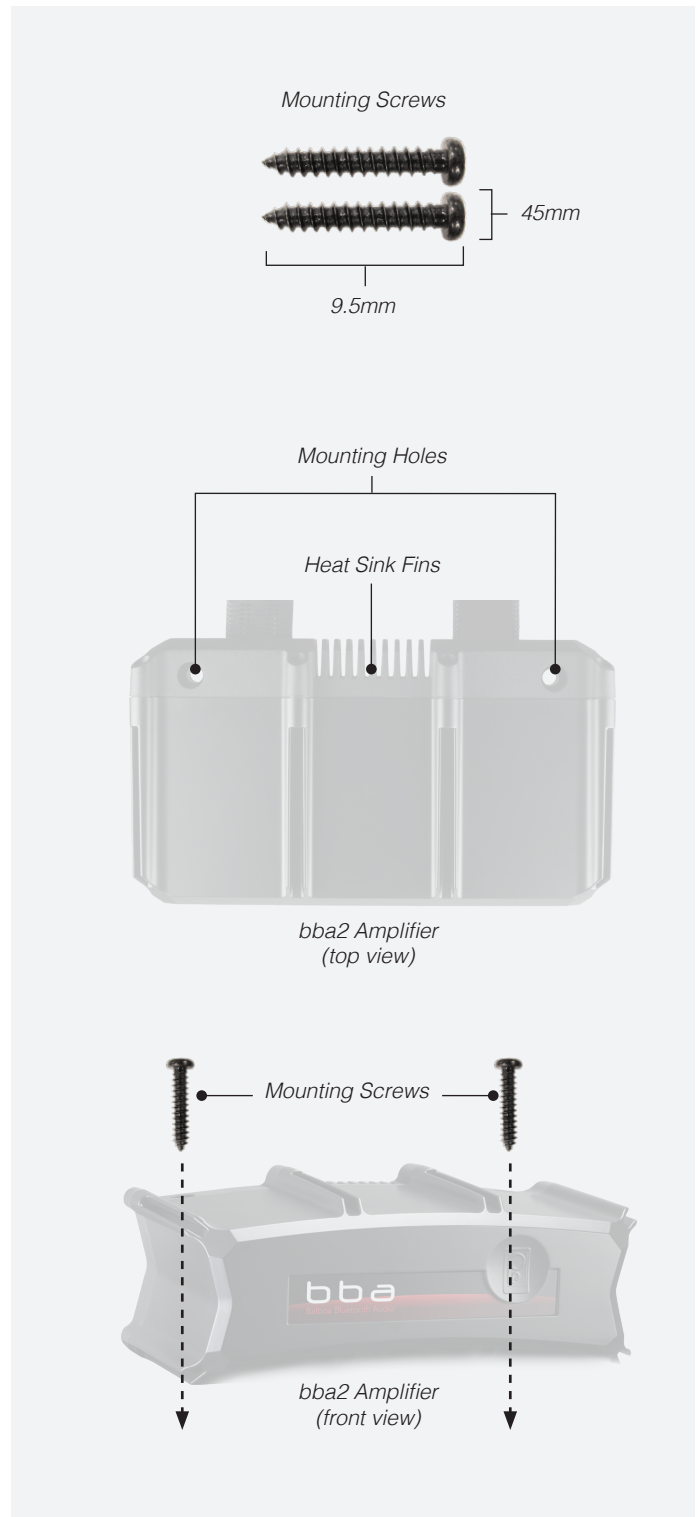

bba2™ Mounting Instructions

6 - Leave a 10 inch gap between the bba2 amplifier and other spa components to help heat management.

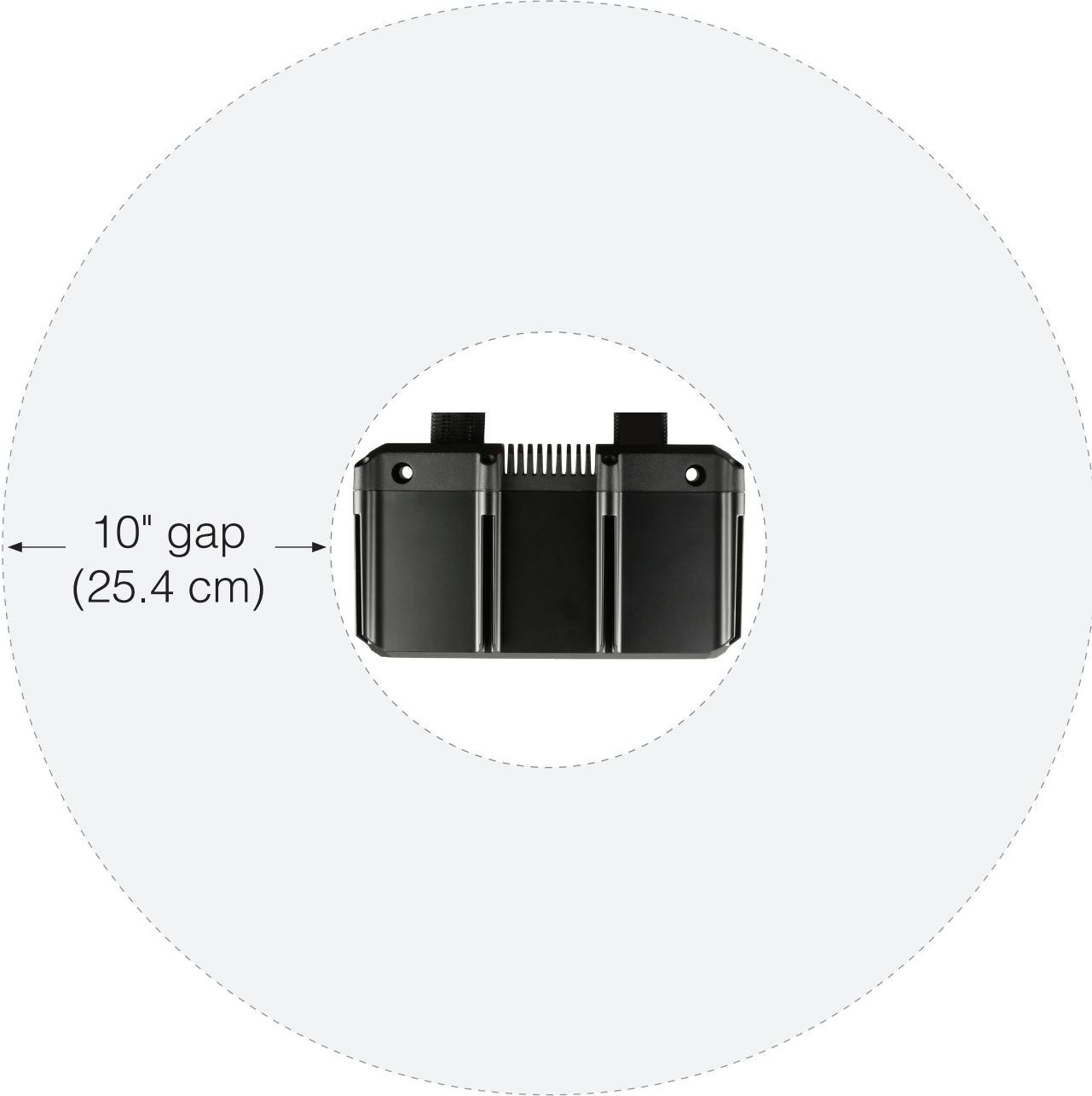

bba[™]2 Amp Connections

Power Wire Specifications

Red wire and blue wire - connect these two wires to a +12V power supply.

Black wire - Connect it to the negative or other good power ground.

Notes

Use the included plug/wire bundle to connect to the power source and speakers.

The red, blue and black power wires should be 16AWG or larger depending on the length to the power supply.

Never operate the unit without the proper power and ground wire. Never ground the speaker leads and never allow the speaker leads to come in contact with each other. The speaker wire should be at least 20 gauge or larger. Be sure to observe the correct polarity on the speaker connections.

Use quality crimp connectors to connect wires together. Seal the connection well with electrical tape.

Never operate the unit without proper fusing. The fuse holder must be located within 2 feet of the power supply. This fuse is to protect the vessel, not the electronics. In case of a short, the fuse will blow instead of the wire burning up. Using other than the recommended fuse rating at the power supply and at the unit may cause damage to the unit and will void your warranty.

Whenever possible, use cable ties, mounting clamps and similar wiring aids. Adding stress relief loop to wiring is also advisable to prevent straining or breakage.

If after reading the directions you feel uncomfortable about installing the unit, or not equipped or competent to do so, you should have this installed by a professional installer.

Connect the white and grey loudspeaker wires to 1 or 2 pairs of loudspeakers. Pay close attention to polarity (black stripe = negative)

Connect the green and purple loudspeaker wires to 1 or 2 pairs of loudspeakers or to a sub woofer.

Bluetooth Connection

(Topside panels with “Icon” GUI)



2 - On the topside panel press the music button. Next, press the power button.

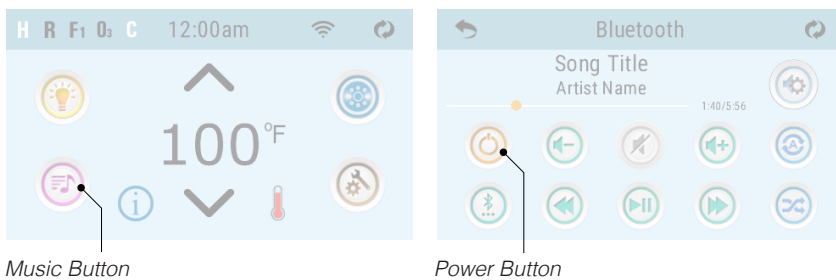

3 - Turn on Bluetooth function of your smart device or music device. 

4 - On your smart device or music device, click search for Bluetooth device. Make sure you are close enough to the spa tub.

5 - Select “PPME70BT” from the pairing list.

6 - Click “Connect.” Once connected, you can now play your favorite music from your smart device or music device.

bba2 operates up to 100 feet in open air.
Ranges vary as they are dependant on installations.

Topside Panel Interface

(Topside panels with "Icon" GUI)



Home Screen

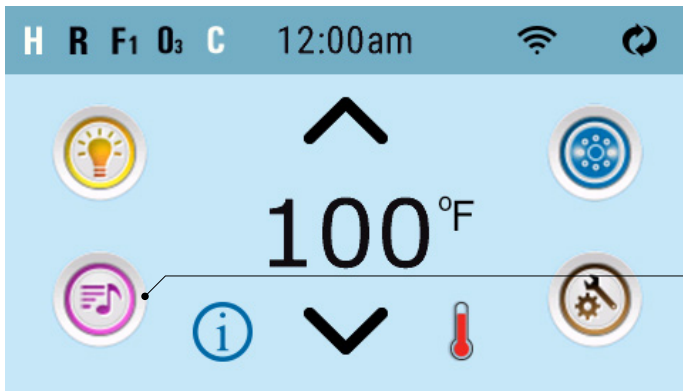

These are spaTouch 2 screens. spaTouch 1 ("Icon" GUI) has the same icons, but some icons are in different positions.

Press this button

Bluetooth Screen

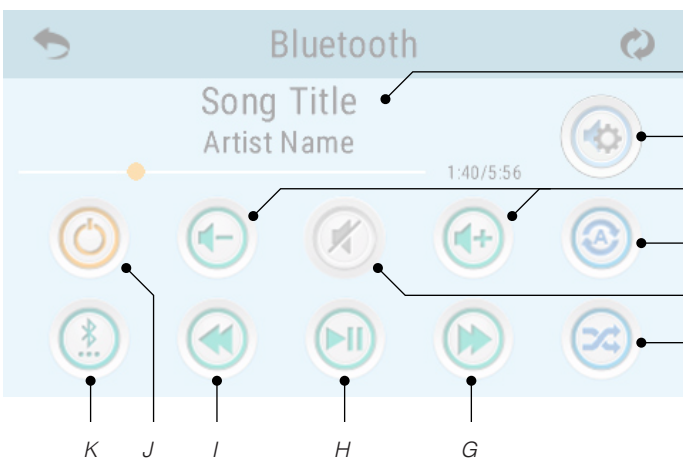

- A - Song, Artist, Song Length, Elapsed Time
- B - Settings
- C - Volume + / -
- D - Repeat
 - Repeat one song
 - Repeat all songs
- E - Mute On/Off
- F - Shuffle
- G - Track forward
- H - Play/Pause
- I - Track back
- J - Power On/Off
- K - Input Modes: Bluetooth, USB, Line in

Some icons such as "Repeat" may not appear if music isn't playing.

Determine Panel Software Version

(Topside panels with “Icon” GUI)

Home Screen

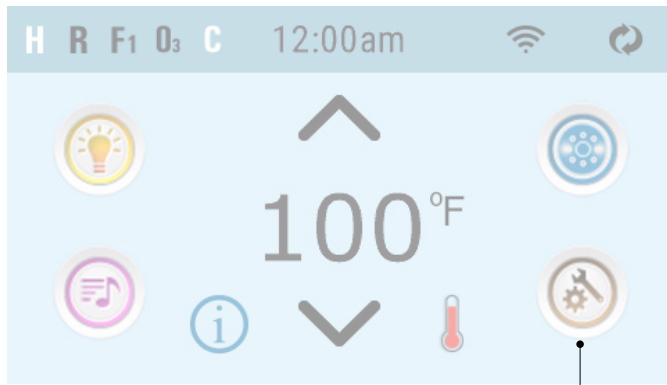

Press “Settings” button.

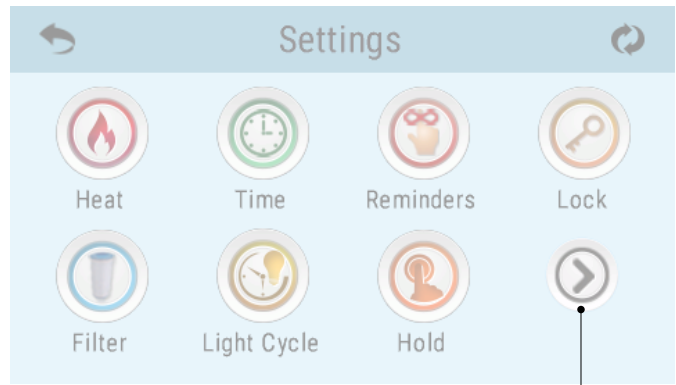

Press “Navigation” button.

“Settings” buttons may vary from system to system.

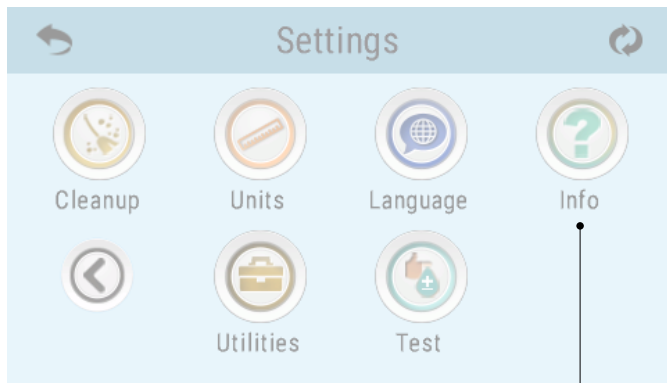

Press “Info” button.

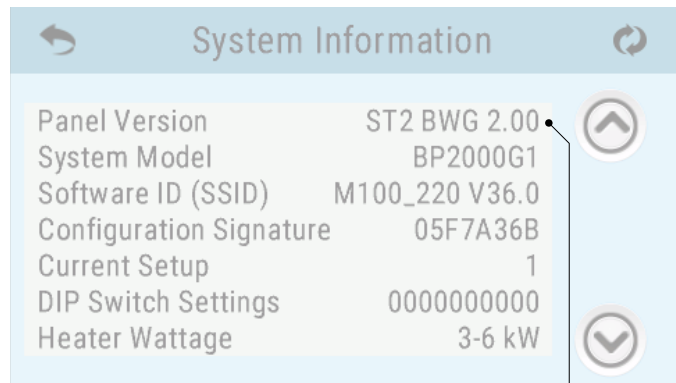

Topside panel software version.

Adjust Settings

(Available only on topside panels with “Icon” GUI)

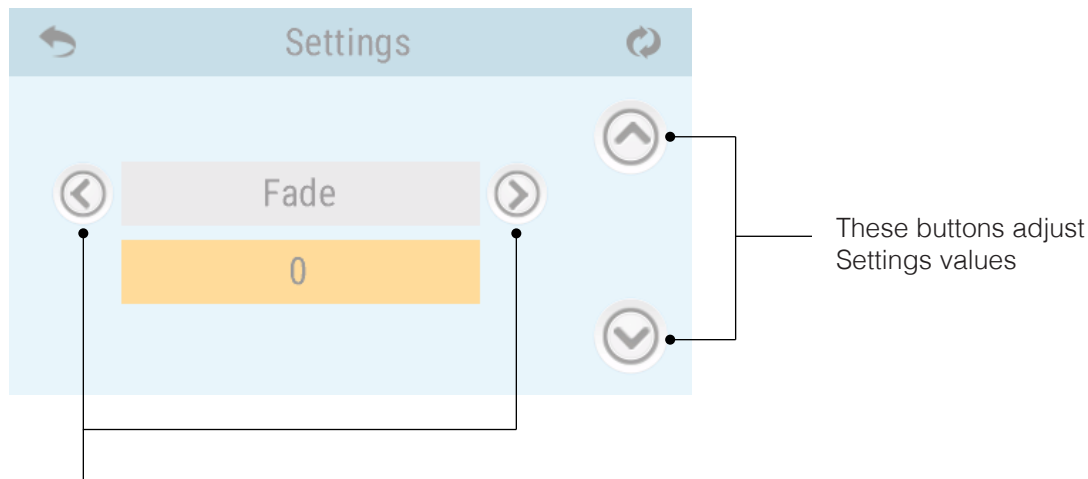
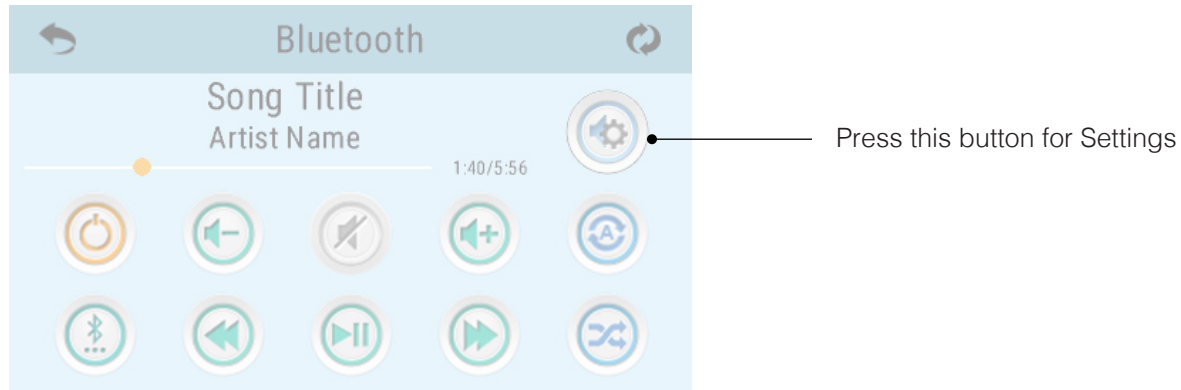

These buttons navigate to the following Settings:

- Balance
- Bass Gain
- EQ Preset
- Fade
- Filter

There are two types of audio filters: Low Pass, High Pass. These filters apply to the rear speaker output only. Select the Low Pass for subwoofers or High Pass for tweeters. Or, select OFF if filtering is not desired. Normal speakers do not require filtering.

Adjust Input Modes





(Topside panels with “Icon” GUI)

The following modes are available: Bluetooth, Line In, USB. All systems are equipped with Bluetooth mode. However, systems may or may not have Line In and USB, as these input modes are optional.



Press this button for Input Modes

Input Mode Icons

	Bluetooth (connected)	} <i>Only spaTouch 2 and spaTouch 1 (software version 3.36 or above) have these icons. Earlier versions of spaTouch 1 have one icon.</i>
	Bluetooth (disconnected)	
	Line In	
	USB	

Topside Panel Interface

(Topside panels with “Menu” GUI)



Topside Panel: spaTouch 1
(software version 2.8 or above)



Topside Panel: TP800
(software version 4.11 or above)



Topside Panel: TP900

Home Screen

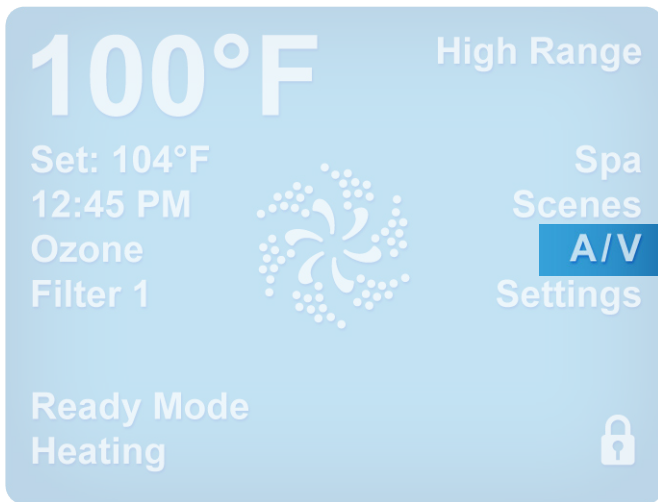

Select “A / V” to navigate to the Bluetooth screen.

“A / V” only appears on the topside panel display if bba2 has been properly connected to the system.

Bluetooth Screen



The “Source” button switches between Bluetooth, USB, and Line In input modes.

Determine Panel Software Version

(Topside panels with “Menu” GUI)

Home Screen

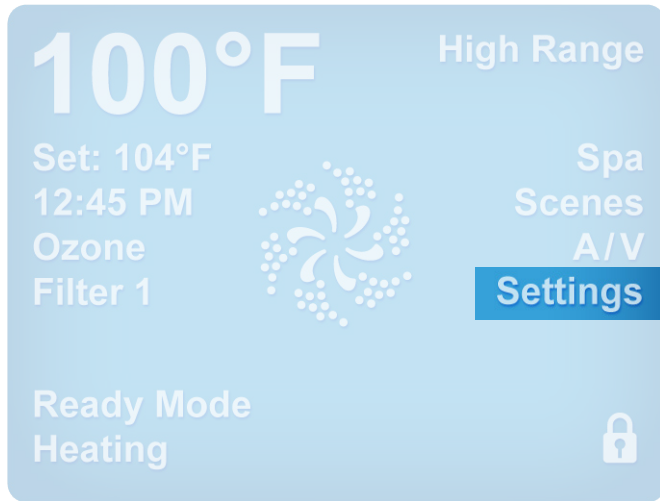

Begin navigation by selecting “Settings.”

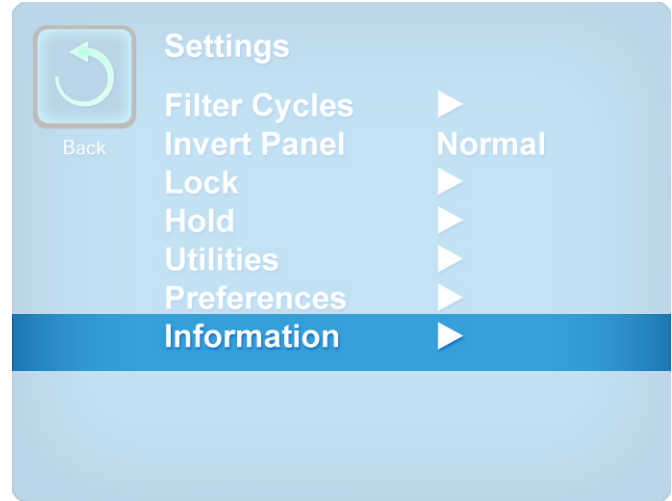

Select “Information.”

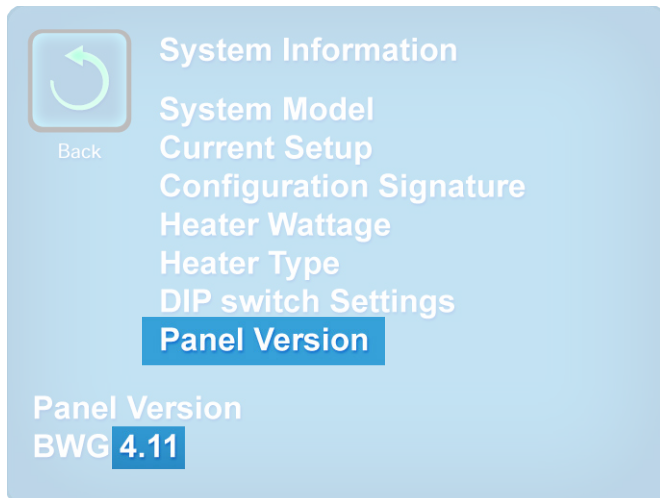

Select “Panel Version.” The panel software version appears at the bottom of the screen. In this example it’s 4.11.

Bluetooth Connection

(Topside panels with “Menu” GUI)

1 - Power up the system pack with bba2 already connected to the system pack.

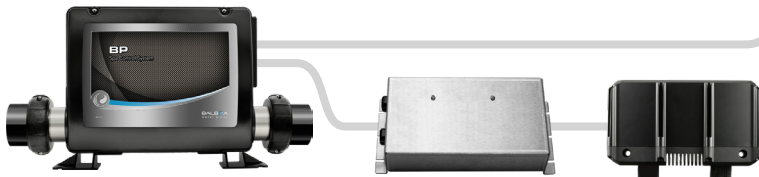

Topside Panel Options



Topside Panel: spaTouch 1
(software version 2.8 or above)



Topside Panel: TP800
(software version 4.11 or above)



Topside Panel: TP900

2 - On the topside panel select the “A / V”.

2A - Select “A / V” on the topside panel.

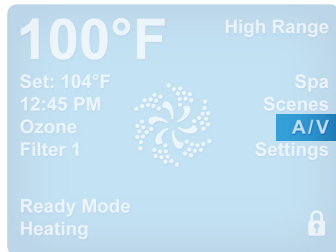

2B - Select “Power.” “Discoverable” may appear.

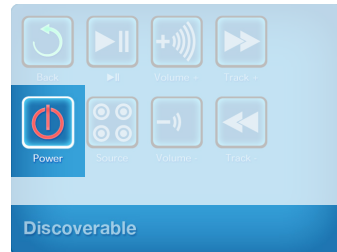

2C - Next, “BT Not Connected” appears.

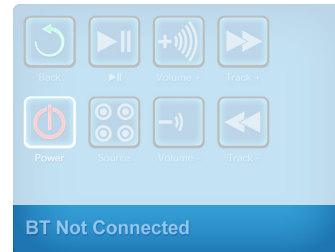

Refer to step 6 below.

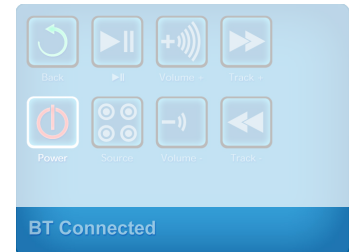

3 - Turn on Bluetooth function of your smart device or music device.



4 - On your smart device or music device, click search for Bluetooth device. Make sure you are close enough to the spa tub.

5 - Select “PPME70BT” from the pairing list.

6 - Click “Connect.” Once connected, you can now play your favorite music from your smart device or music device. “BT Connected” appears on the topside panel display.

bba2 operates up to 100 feet in open air. Ranges vary as they are dependant on installations.

Using USB

Connect USB drive here (image 1). You can select tracks, control volume and play/pause (image 2 & 3). Volume control is also available (image 2 & 3). If the topside panel has “shuffle” and “repeat”, they should work also.

USB display on panels with “Menu” GUI

With a newer TP800 (software version 4.11 or above) or with a newer “Menu” spaTouch 1 (software version 2.8 or above), the USB input is selectable and displays as “USB”. With an older TP800 or an older “Menu” spaTouch 1 or a TP900, the USB input is selectable, but it displays a Bluetooth indication.

To work with BBA at all, a TP800 or TP900 must be version 3.13 or above, and a “Menu” spaTouch 1 must be version 1.7 or above.

Image 1

Balboa Audio (bba2) amplifier

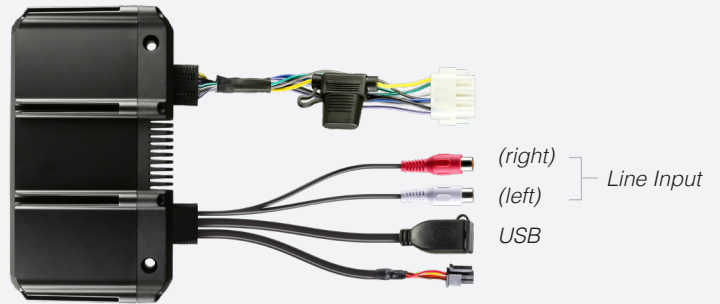
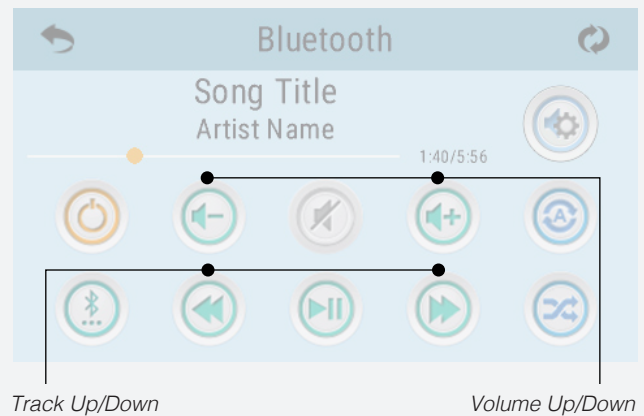

Image 2

Topside panel display with “Icon” GUI



Using Line In

You can connect any headphone output to the Line In connectors (image 1), but you will likely need an adapter cable because of the different connectors. Volume is the only controllable feature when using Line In.

Image 3

Topside panel display with “Menu” GUI

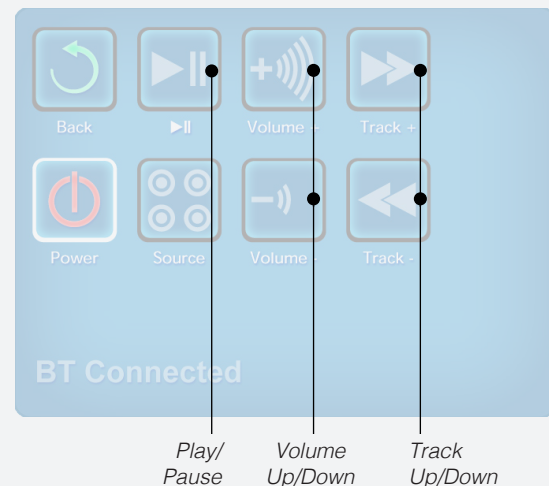

Topside Panel Interface

(Topside panels: TP600, TP400)

Spa Equipment

The system pack and all electronic components connected to the system pack are referred to as “**system**” in this manual.

The power supply connects to the system pack at the circuit board connector labeled “A / V.” Refer to the system pack wire diagram for circuit board connector positions. The wire diagram is inside the system pack.

Topside Panel Options

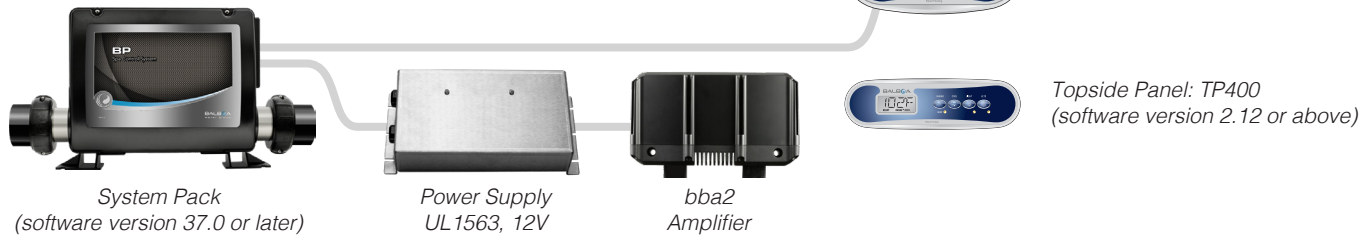

Determine Panel Software Version

(Topside panels: TP600, TP400)

1 - Start at the home screen. The water temperature is displayed by default.



2 - Press Temp (or Warm or Cool. This applies to all steps where Temp is pressed.) to begin navigation. The set temperature (not the water temperature) will begin flashing in the LCD display.



3 - Press Light until this screen appears. “UTIL” is an abbreviation for “Utilities.”



4 - Press Temp once to make this screen appear. “INFO” is an abbreviation for “Information.”



5 - Press Temp once again to make this screen appear. “SSID” stands for “System software identification.”



6 - Press Light until this screen appears. “PANL” is an abbreviation for “Panel.”



7 - Press Temp to view the panel software version.



Bluetooth Connection

(Topside panels: TP600, TP400)

Topside Panel Options

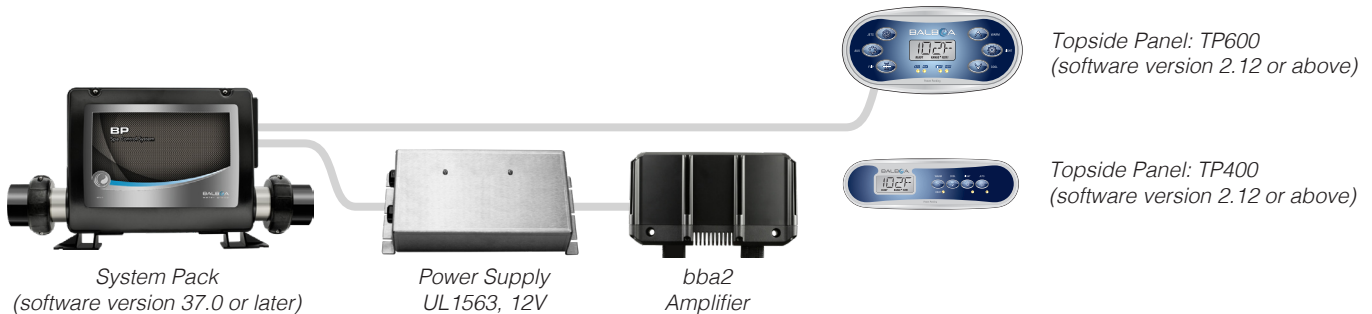

1 - Power up the system pack with bba2 already connected to the system pack.

2 - Turn ON bba2 (view section below).

3 - Turn ON the Bluetooth function of your smart device or music device.



4 - On your smart device or music device, click search for Bluetooth device. Make sure you are close enough to the spa tub.

5 - Select "PPME70BT" from the pairing list. If PPME70BT does not appear, repeat steps 1 - 4.

6 - Click "Connect." Once connected, you can now play your favorite music from your smart device or music device. Some devices may auto-connect in less than a minute.

bba2 operates up to 100 feet in open air. Ranges vary as they are dependant on installations.

Turn ON/OFF bba2™

(Topside Panels: TP600, TP400)

1 - Start at the home screen. The water temperature is displayed by default.

2 - Press Temp (or Warm or Cool) to begin navigation. The set temperature (not the water temperature) will begin flashing in the LCD display.

3 - Press Light until this screen appears. "BT" is an abbreviation for "Bluetooth."

4 - Press Temp to turn ON/OFF bba2. The Home screen appears, when Temp is pressed. No visual cue indicates whether bba2 is ON or OFF. Play music on a smart device to determine whether bba2 is ON or OFF.



Note: bba2 is always at maximum volume when used with TP600 and TP400 topside panels. Reduce volume on the smart device before turning ON bba2.

Troubleshooting

Problem: Song title appears only sometimes or never.

Solution: A few music player apps never send song title and other info over Bluetooth, so try another app. Also, some music player apps don't send song title if playing automatically in the background, only if the app is "visibly running" on the device, so try "opening" the app which is playing in the background.

Problem: An extension cable is needed to install bba2.

Solution: The following extension cables provide flexibility in bba2 placement.

Optional Extension Cables		
Material Number	Description	Length
25662-3	CABLE EXTENSION TP PANELS	100 FT
25662-2	CABLE EXTENSION TP PANELS	50 FT
25662-1	CABLE EXTENSION TP PANELS	25 FT
25662	CABLE EXTENSION TP PANELS	7 FT

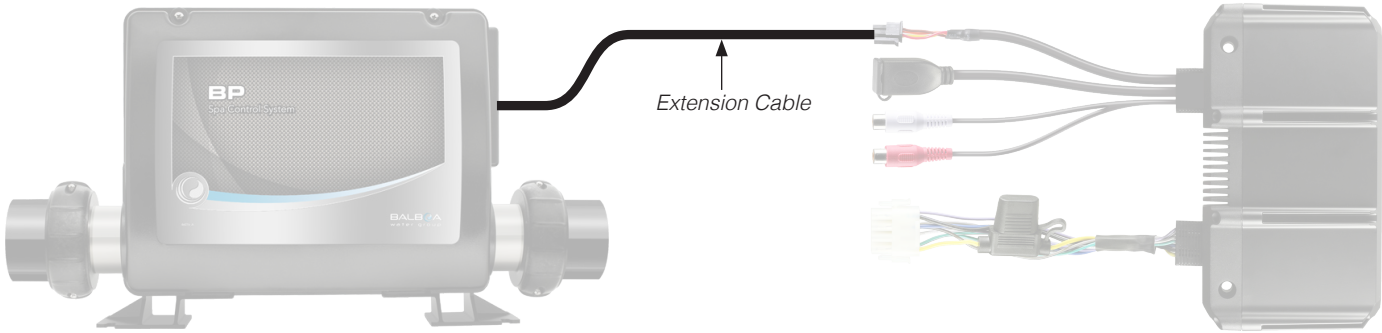

Intellectual Property Advisement

All Intellectual property, as defined below, owned by or which is otherwise the property of Balboa Water Group or its respective suppliers relating to the Balboa Water Group including but not limited to, accessories, parts, or software relating thereto bba™ - Balboa Bluetooth Audio (AMP) (the “System”), is proprietary to Balboa Water Group and protected under federal laws, state laws, and international treaty provisions. Intellectual Property includes, but is not limited to, inventions (patentable or un-patentable), patents, trade secrets, copyrights, software, computer programs, and related documentation, and other works of authorship. You may not infringe or otherwise violate the rights secured by the Intellectual Property. Moreover, you agree that you will not (and will not attempt to) modify, prepare derivative works of, reverse engineer, decompile, disassemble, or otherwise attempt to create source code from the software. No title to or ownership in the Intellectual Property is transferred to you. All applicable rights of the Intellectual Property shall remain with Balboa Water Group and its suppliers.



42295-F

© 2019 Balboa Water Group. Single Source Solution. All rights reserved.
3030 Airway Avenue | Costa Mesa, CA 92626 | p 714.384.0384 | www.balboawater.com
We reserve the right to change technical data without further notice.